

Unsere Schleifpapiere zeichnen sich durch folgende Vorteile aus:

- Edelkorund mit hoher Kornschärfe
- Schleifen mit wenig Anpressdruck möglich
- festes Papier mit hoher Kantenstabilität
- einfacher Schleifblattwechsel durch Klett
- wirtschaftliches Bearbeiten von allen Holzarten



Für eine hohe Abtragleistung auf Holz und Metall wird eine Körnung von 40 bis 180 verwendet. Diese Schleifpapiere haben eine rötlichbraune Färbung. Das Trägermaterial ist Papier 250g/m<sup>2</sup>. Das verwendete Schleifkorn besteht aus Korund.





Für Feinstschliffarbeiten und Schleifen von Lacken und Spachtel wird eine Körnung ab 220 verwendet. Diese Schleifpapiere haben eine weißgraue Farbe. Das Trägermaterial ist Papier 120g/m<sup>2</sup>. Das verwendete Schleifkorn besteht aus Korund und ist mit einer Zink-Stearat-Beschichtung gegen vorzeitiges Zusetzen versehen.

115 x 140 mm		Packungsgröße	Körnung	Best.-Nr.
 60 - 180	 *240	 BO4555	60	P-329 04
			80	P-364 07
			100	P-006 36
			120	P-329 26
			150	P-006 58
			180	P-364 13
			240*	P-014 26





115 x 102 mm		Klettverschluss	Packungsgröße	Körnung	Best.-Nr.
 60 - 180	 *240 - 320	 BO4555/66	 BO4565	40	P-330 87
				60	P-330 93
				80	P-331 02
				100	P-331 18
				120	P-331 24
				150	P-331 30
				180	P-331 46
				240*	P-358 79
				320*	P-015 57





95 mm Dreieck		Klettverschluss	Packungsgröße	Körnung	Best.-Nr.
 40 - 180	 *240 - 320	 BO4565	 BO4565	40	P-332 55
				60	P-332 61
				80	P-332 77
				100	P-332 83
				120	P-332 99
				150	P-333 08
				180	P-333 14
				240*	P-427 59
				320*	P-016 44

95 mm Dreieck		Klettverschluss	Packungsgröße	Körnung	Best.-Nr.
 40 - 180	 *240	 BO4566	 BO4566	40	P-428 68
				60	P-206 50
				80	P-428 80
				100	P-428 96
				120	P-429 05
				150	P-206 94
				180	P-207 03
				240*	P-207 19

93 x 230 mm		Packungsgröße	Körnung	Best.-Nr.	
A		10 fach Lochung 	Set à 10 Stück	40	P-361 36
				60	P-004 24
				80	P-361 42
				100	P-329 54
B		8 fach Lochung 	Set à 10 Stück	40	P-318 37
				60	P-318 43
				80	P-318 59
				100	P-318 65

93 x 230 mm		Klettverschluss 	Packungsgröße	Körnung	Best.-Nr.
			Set à 10 Stück	40	P-318 71
				60	P-318 87
				80	P-318 93
				100	P-315 16

115 x 280 mm		Packungsgröße	Körnung	Best.-Nr.	
	40 - 180		Set à 10 Stück	40	P-330 09
				60	P-330 15
				80	P-330 21
				100	P-330 37
				120	P-330 43
				150	P-021 41
				180	P-021 57
				240*	P-330 71
	*240			40	P-330 09
				60	P-330 15
				80	P-330 21
				100	P-330 37
				120	P-330 43
				150	P-021 41
				180	P-021 57
				240*	P-330 71

115 x 232 mm		Klettverschluss 	Packungsgröße	Körnung	Best.-Nr.
	40 - 180		Set à 10 Stück	40	P-331 74
				60	P-331 80
				80	P-331 96
				100	P-022 00
				120	P-332 11
				150	P-332 27
				180	P-332 33
				240*	P-022 44
	*240			40	P-331 74
				60	P-331 80
				80	P-331 96
				100	P-022 00
				120	P-332 11
				150	P-332 27
				180	P-332 33
				240*	P-022 44













125 mm Ø		Klettverschluss 	Packungsgröße	Körnung	Best.-Nr.
	40 - 180		Set à 10 Stück	40	P-435 33
				60	P-435 49
				80	P-435 55
				100	P-435 61
				120	P-435 77
				180	P-435 83
				240*	P-435 99
					*240
60	P-435 49				
80	P-435 55				
100	P-435 61				
120	P-435 77				
180	P-435 83				
240*	P-435 99				



150 mm Ø	Klettverschluss	Packungsgröße	Körnung	Best.-Nr.
60 - 180            *220 - 600	BO6030 BO6040	Set à 10 Stück	40	P-378 39
			60	P-319 24
			80	P-319 30
			100	P-319 46
			120	P-319 52
			150	P-319 68
			180	P-319 74
			220*	P-379 04
			240*	P-379 10
			320*	P-379 26
			400*	P-379 32
600*	P-317 06			

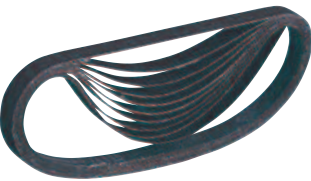

Staubsäcke	Bezeichnung	für Modell		Best.-Nr.	
		BO4555	BO4565	16 60 78-4	
		BO4556	BO4566		
		BO4900V	BO5021	BO6030	15 15 17-7
		(Adapter erforderlich)		15 15 18-5	
		9046		15 24 56-4	
	BO5010	Staubsack		16 60 47-5	
		Adapter		41 60 64-8	
		Ring		25 72 02-1	
		Staubsauffitting		41 60 63-0	
	Staubsack Papier VPE 5 Stück	BO4555	BO4566	19 37 12-3	
	Staubsauffitting inkl. 1 Papiersack	BO4556	BO5010	19 39 32-9	
		BO4565	BO5021		
	Staubsack Papier VPE 5 Stück	BO4900V	BO3700	19 32 93-7	
		9046		19 32 94-5	
	Staubsauffitting inkl. 1 Papiersack	BO6030			



Lochungsplatten	für Modell		Best.-Nr.
	BO4555	BO4565	41 30 94-0
	BO4556	BO4566	
	9036		16 32 92-3
	BO3700		19 29 89-7
	BO4900V	9046	19 25 23-3
	BO4901		

Schleifteller BO6030 / BO6040	für Modell		Best.-Nr.
	hart	für hohe Abtragleistung	A-878 06
	weich	für normale Anwendungen	A-878 12
	superweich	für wellige Untergründe	A-878 28



6 x 533 mm		Größe 6 x 533 mm	Körnung	Best.-Nr.		
  <p>9032</p>	<b>Schleifarm 6 mm</b>  Bandbreite 6 mm Set á 25 St.			12 51 57-7		
			40	P-393 88		
			60	P-393 94		
			80	P-394 03		
			100	P-394 19		
			120	P-394 25		
9 x 533 mm		Größe 9 x 533 mm	Körnung	Best.-Nr.		
  <p>9032</p>	<b>Schleifarm 9 mm</b>  Bandbreite 9 mm Set á 25 St.			12 51 58-5		
			40	P-394 31		
			60	P-394 47		
			80	P-394 53		
			100	P-394 69		
			120	P-394 75		
13 x 533 mm		Größe 13 x 533 mm	Körnung	Best.-Nr.		
  <p>9032</p>	<b>Schleifarm 13 mm</b>  Bandbreite 13 mm Set á 25 St.			12 51 59-3		
			40	P-394 81		
			60	P-394 97		
			80	P-395 06		
			100	P-395 12		
			120	P-395 28		
30 x 533 mm		Größe 30 x 533 mm	Körnung	Best.-Nr.		
  <p>9031</p>	Set á 5 Stück			P-000 88		
			40	P-000 94		
			60	P-001 03		
			80	P-001 19		
			100	P-001 25		
			120	P-001 31		
			150	P-001 47		
			180	P-001 53		
		  <p>9031</p>	<b>Schleifband für Glas und Keramik</b> Set á 5 Stück			P-013 95
					40	P-014 04
	60			P-011 99		
	80			P-012 08		
	100			P-012 08		
	120			P-012 20		
	150	P-012 36				
	180					
76 x 457 mm		Größe 76 x 457 mm	Körnung	Best.-Nr.		
  <p>9910 9911</p>	Set á 5 Stück			P-370 91		
			40	P-371 00		
			60	P-371 16		
			80	P-371 22		
			100	P-371 38		
			120	P-201 27		
			150	P-201 33		
			180	P-371 50		
			240*			
			Set 40/80/100/120	P-201 55		

76 x 533 mm	Größe 76 x 533 mm	Körnung	Best.-Nr.
  <p>9902 9903</p>	<p>Set á 5 Stück</p>	40	P-371 72
		60	P-371 88
		80	P-371 94
		100	P-372 03
		120	P-372 19
		150	P-002 12
		240*	P-002 34

76 x 610 mm	Größe 76 x 610 mm	Körnung	Best.-Nr.
  <p>9920</p>	<p>Set á 5 Stück</p>	40	P-373 12
		60	P-373 28
		80	P-373 34
		100	P-373 40
		120	P-373 56
		150	P-003 09
		240*	P-003 21

100 x 610 mm	Größe 100 x 610 mm	Körnung	Best.-Nr.
  <p>9403 9404</p>	<p>Set á 5 Stück</p>	40	P-368 87
		60	P-368 93
		80	P-369 02
		100	P-369 18
		120	P-369 24
		150	P-369 30
		240*	P-369 46

Staubsäcke		für Modelle	Best.-Nr.
	<p>Staubsack Stoff mit Reissverschluss zum einfachen Entleeren</p>	9403	12 25 62-9
		9404	12 25 91-2
		9902	12 25 91-2
		9903	12 25 91-2
		9910	12 25 48-3
		9911	12 25 48-3
		9920	12 25 91-2

Schleifplatten		für Modelle	Best.-Nr.
 <p>Zur Bearbeitung von Metalloberflächen</p>	<p>Graphit</p>	9403	42 40 57-1
		9404	19 32 01-8
		9902	42 33 15-2
		9903	42 33 15-2
		9920	42 33 16-0
 <p>Zur Bearbeitung von Holzoberflächen</p>	<p>Kork</p>	9403	42 90 58-9
		9404	19 32 02-6
		9902	42 33 12-8
		9903	42 33 12-8
 <p>Zur Bearbeitung von Holz- und Metalloberflächen</p>	<p>Stahl</p>	9920	42 33 13-6
		9403	15 09 80-1
		9404	15 17 51-9
		9902	15 17 49-6
		9903	15 17 49-6
		9920	15 17 50-1

Schleifrahmen	Bezeichnung	für Modelle	Best.-Nr.
	Schleifrahmen	9404	19 30 72-3
		9902	19 30 70-7
		9903	19 30 70-7
		9920	19 30 71-5
	Führungsträger	9032	19 36 18-5

Stationäreinrichtung	Bezeichnung	für Modelle	Best.-Nr.
	Stationäreinrichtung	9404	19 30 55-3
		9902	
		9903	
		9920	
	Schraubzwingen Paar	9910	19 26 94-6
		9911	

Bürstenschleifer	Körnung	Best.-Nr.	Körnung	Best.-Nr.		
Lamellenschleifbürste Zum Schleifen von Oberflächen, Anschleifen von Farben etc.	40	P-011 27		60	P-044 22	
	80	P-011 55		80	P-044 38	
Messingstahldrahtbürste 0,5 mm. Zur Holzstruk- turierung, sehr gut geeignet für hohen Abrieb auf Weich- und Hartholz, Entrosten und Reinigen		P-656 48		120	P-044 44	
				180	P-044 50	
Stahldrahtbürste 0,5 mm Zum Entrosten und Entlacken und zur Reinigung von Beton- Schalungsteilen		P-044 00		320	P-044 66	
				Schleifnylon-Bürste, Original	80	79 43 84-3
Fibrebürste Zum Einarbeiten von Beize und Lack und zum anschließenden Glätten		P-044 16		80	P-180 35	
				120	P-180 41	
				180	P-180 29	
Baumwollpolierbürste Zum Polieren von Oberflächen auch unter Zugabe von entsprechenden Polierpasten		79 43 81-9		80	P-180 57	
				120	P-192 33	
				180	P-192 49	
					Absaugstutzen	41 08 99-9